

Mounting Instructions

Fixed Universal Screen Bracket
052.1000 / 052.2000 / 052.6000

1

Mounting screen profiles

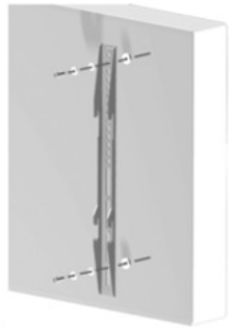

Mount the screen profiles to the back of the screen. Divide the profiles as well as possible.

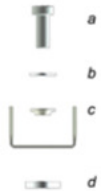

a. bolt b. washer c. cuff d. spacer

* use M4, M5, M6 or M8 mounting material (depending on flat screen) (spacers only if necessary)

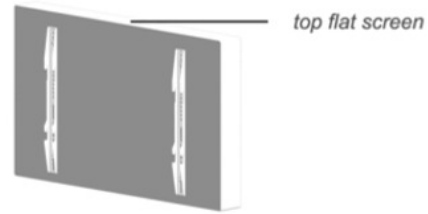

2x

2

Ensure there is a minimum distance of least at least 1.5 m between the wall and one side of the mounting plate, to install the locking bar at step 4.

Mounting back plate

A

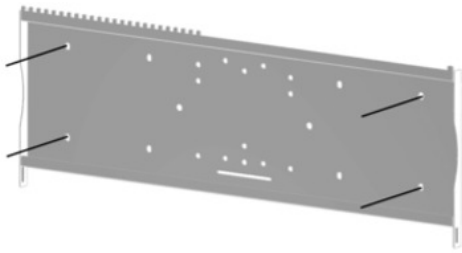

Mounting back plate to the wall

B

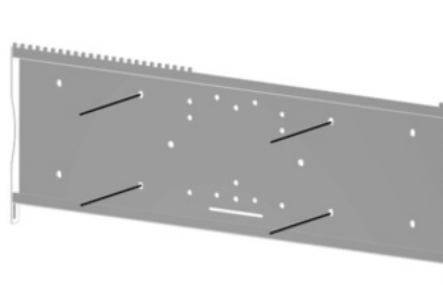

Mounting back plate to the wall (alternative mounting positions)

C

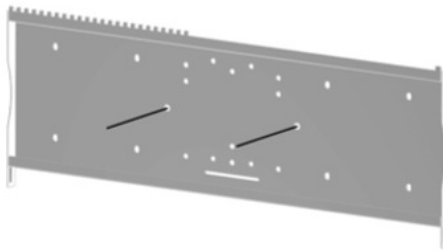

Mounting back plate to truss

D

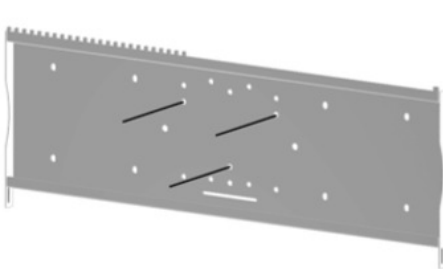

Mounting back plate to flat screen stand

Mounting Instructions

Fixed Universal Screen Bracket
052.1000 / 052.2000 / 052.6000

3

Connecting flat screen to base plate

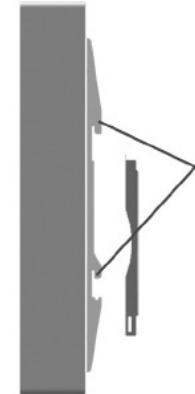
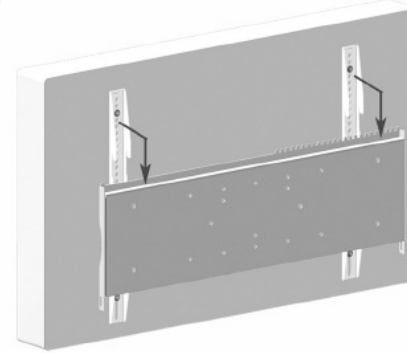

Hook on connecting profiles to the back plate

4

Transit locking bar

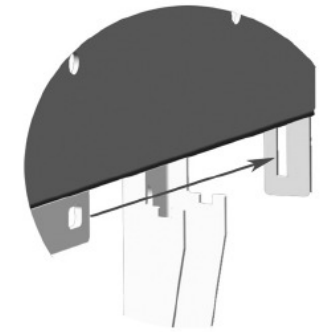
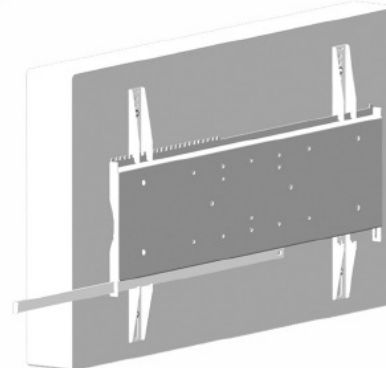

Transit the locking bar through the 'cheeks' of the back plate.

5

Lock (optional)

